

ALL FITTINGS ACTUAL SIZE (#14, #16 not shown)

FEMALE FLARE (no o-ring used)

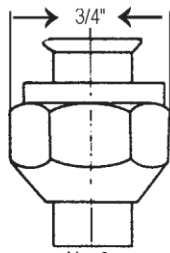

No. 6
5/8" - 18 Thread

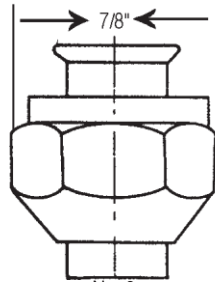

No. 8
3/4" - 16 Thread

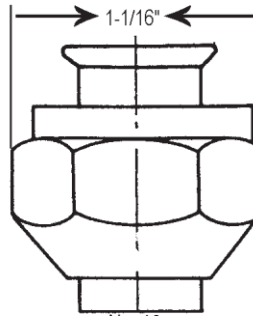

No. 10
7/8" - 14 Thread

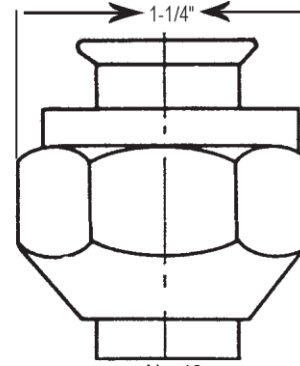

No. 12
1 - 1/16" - 14 Thread

MALE INSERT O-RING (o-ring located on inside)

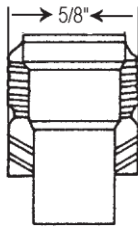

No. 6
5/8" - 18 Thread

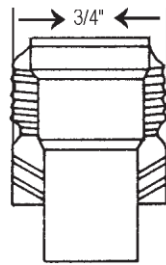

No. 8
3/4" - 16 Thread

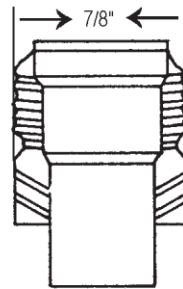

No. 10
7/8" - 14 Thread

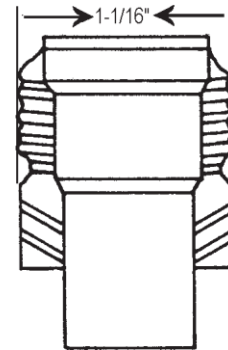

No. 12
1 - 1/16" - 14 Thread

MALE O-RING (o-ring located on outside)

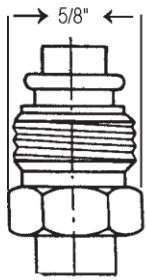

No. 6
5/8" - 18 Thread

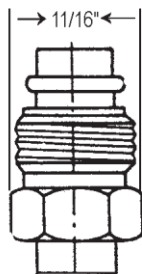

No. 7
SPECIAL GM/IHC
DRYER FITTING
1 1/16" - 16 Threads

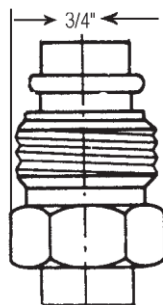

No. 8
3/4" - 18 Thread

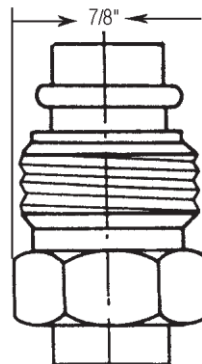

No. 10
7/8" - 18 Thread

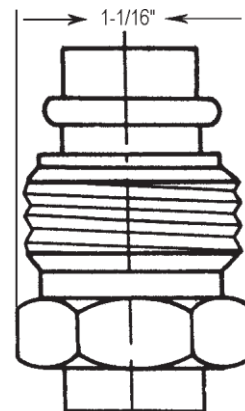

No. 12
1 - 1/16" - 16 Thread

FEMALE O-RING (o-ring located on outside)

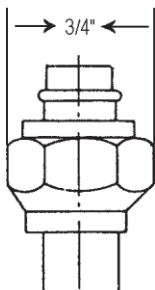

No. 6
5/8" - 18 Thread

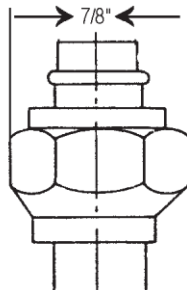

No. 8
3/4" - 16 Thread

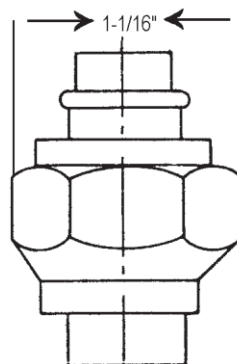

No. 10
7/8" - 14 Thread

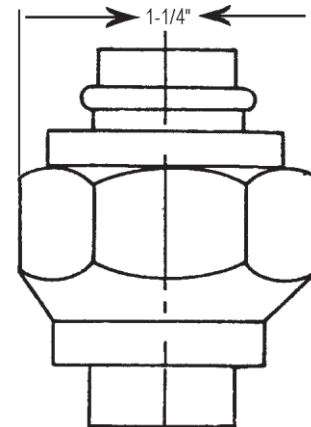

No. 12
1 - 1/16" - 14 Thread